

Pompe SACEMI - Type AP



Pompe machine-outil pour transfert de fluides contenant des impuretés

Moteur triphasé 220/380V - Classe F - IP55

Température de liquide max. : 90°C

Applications :

- Machines outils (perçuses, tours, fraiseuses)
- Machines de traitement du verre
- Systèmes de traitement de surface
- Systèmes de filtration

> Courbes hydrauliques

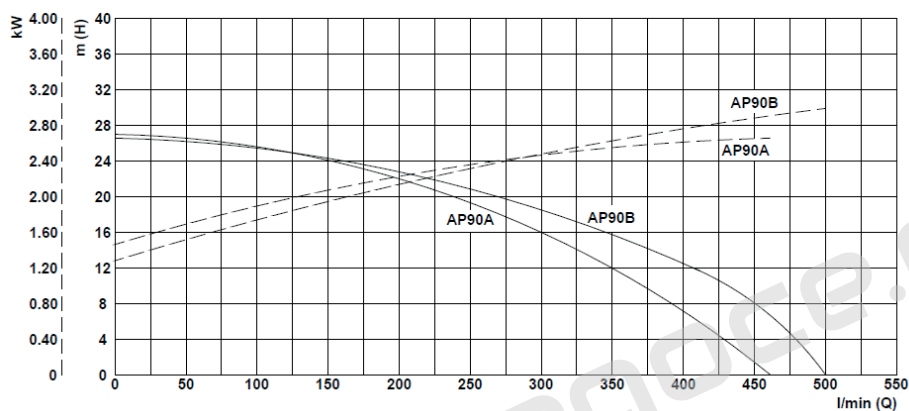

> Dimensions

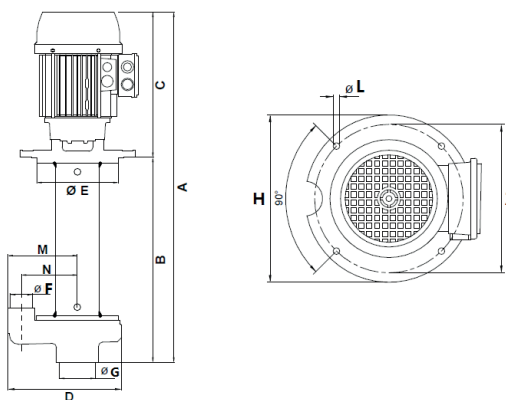

Réf. ABE	kW		A mm	B mm	C mm	D mm	E mm	F mm	G	H mm	I mm	L mm	M mm	N mm
	Abs.	Nom.												
POMP.AP90B450	3,58	3,00	805	450	355	280	240	112	2 1/2"	300	270	13	170	136